

Clariflex®



ROTARY TOOL SET

MODEL NO: CRT130

PART NO: 6462000

OPERATION & MAINTENANCE INSTRUCTIONS

UK
CA | CE

ORIGINAL INSTRUCTIONS

GC1023 -rev 4

INTRODUCTION

Thank you for purchasing this CLARKE Rotary Tool Kit.

Before attempting to use this product, it is essential that you read this manual thoroughly and carefully follow all instructions given. In doing so you will ensure the safety of yourself and that of others around you, and you can also look forward to the product giving you long and satisfactory service.

Please keep these instructions in a safe place for future reference.

SPECIFICATION

Voltage	230V, 50Hz
Power rating	130 W
IP Rating	20
Electrical insulation class	II
No-load speed	10,000 - 35,000 rpm
Collet capacity	max 3.2 mm
Max grinding disc	35 mm
Max drill bit	3.2 mm
Weight	1.22 kg
Vibration	1.42 m/s ² (uncertainty factor 1.5m/s ²)
Sound pressure level	72 dB LpA
Sound power level	83 dB LWA (uncertainty factor = 3)

GUARANTEE

This CLARKE product is guaranteed against faulty manufacture for a period of 12 months from the date of purchase. Please keep your receipt as proof of purchase.

This guarantee is invalid if the product is found to have been abused or tampered with in any way, or not used for the purpose for which it was intended. Faulty goods should be returned to their place of purchase, no product can be returned to us without prior permission.

This guarantee does not effect your statutory rights.

SAFETY PRECAUTIONS



WARNING: READ ALL INSTRUCTIONS. FAILURE TO FOLLOW ALL INSTRUCTIONS LISTED BELOW MAY RESULT IN ELECTRIC SHOCK, FIRE AND/OR SERIOUS INJURY. THE TERM "POWER TOOL" IN ALL WARNINGS LISTED BELOW REFERS TO YOUR TOOL KIT.

WORK AREA

1. Keep work area clean and well lit. *Cluttered and dark areas invite accidents.*
2. **DO NOT operate power tools in explosive atmospheres, such as in the presence of flammable liquids, gases or dust.** *Power tools create sparks which may ignite the dust or fumes.*
3. **Keep children and bystanders away while operating a power tool.** *Distractions can cause you to lose control.*

ELECTRICAL SAFETY

1. Avoid body contact with earthed or grounded surfaces such as pipes, radiators, ranges or refrigerators. There is an increased risk of electric shock if your body is earthed or grounded.
2. **DO NOT expose power tools to rain or wet conditions.** *Water entering a power tool will increase the risk of electric shock.*
3. **When operating a power tool outdoors, use an extension cord suitable for outdoor use.** *Use of a cable suitable for outdoor use reduces the risk of electric shock.*

PERSONAL SAFETY

1. Stay alert, watch what you are doing and use common sense when operating a power tool. **DO NOT** use a power tool while you are tired or under the influence of drugs, alcohol or medication. A moment of inattention while operating power tools may result in personal injury.
2. **Use safety equipment. Always wear eye protection.** *Safety equipment such as dust mask, non-skid safety shoes, or hearing protection used for appropriate conditions will reduce personal injuries.*
3. **Avoid accidental starting.** Ensure the switch is in the off position before plugging in.
4. **Remove any adjusting key or wrench before turning the power tool on.** *A wrench or a key left attached to a rotating part of the power tool may result in personal injury.*

5. **DO NOT overreach. Keep proper footing and balance at all times.** *This enables better control of the power tool in unexpected situations.*
6. **Dress properly. Do not wear loose clothing or jewellery. Keep your hair, clothing and gloves away from moving parts.** *Loose clothes, jewellery or long hair can be caught in moving parts.*

POWER TOOL USE AND CARE

1. **DO NOT** force the power tool. Use the correct power tool for your application. The correct power tool will do the job better and safer at the rate which it was designed.
2. **DO NOT** use the power tool if the switch does not turn it on and off. Any power tool that cannot be controlled with the switch is dangerous and must be repaired.
3. Disconnect the tool before making any adjustments, changing accessories, or storing power tools. Such preventive safety measures reduce the risk of starting the power tool accidentally.
4. Store idle tools out of the reach of children and do not allow persons unfamiliar with the power tool or these instructions to operate the power tool. Power tools are dangerous in the hands of untrained users.
5. Maintain power tools. Check for misalignment or binding of moving parts, breakage of parts and any other condition that may affect the power tools operation. If damaged, have the power tool repaired before use. Many accidents are caused by poorly maintained power tools.
6. Keep cutting tools sharp and clean. Well maintained cutting tools with sharp cutting edges are less likely to bind and are easier to control.
7. Use the power tool, accessories and tool bits etc, in accordance with these instructions and in the manner intended for the particular type of power tool, taking into account the working conditions and the work to be performed. Use of the power tool for operations different from intended could result in a hazardous situation.

SERVICING

1. Have your power tool serviced by a qualified repair person using only identical replacement parts. This will ensure that the safety of the power tool is maintained.

ADDITIONAL INSTRUCTIONS FOR ROTARY TOOLS

1. Only use accessories supplied for use with this tool.
2. NEVER use worn or cracked accessories.

3. Hold the tool away from your face when switching on.
4. Keep your fingers away from rotating accessories.
5. Be careful not to accidentally hit any foreign objects in the workpiece.
6. If an accessory jams, switch the tool off and disconnect from the power supply before attempting to free the accessory.
7. Clamp the workpiece securely whenever possible.
8. Thoroughly remove all dust after sanding.
9. **Take special care when sanding paint which is possibly lead based or when sanding some laminates and metal which may produce toxic dust.**
 - Wear a dust mask specifically designed for protection against lead paint dust and fumes and ensure that persons within or entering the work area are also protected.
 - **DO NOT** let children or pregnant women enter the work area.
 - **DO NOT** eat, drink or smoke in the work area.
10. Abrasive wheels should be stored and handled with care. When not in use, accessories should be stored in the box provided for protection.
11. Inspect grinding wheels/accessories before use. **DO NOT** use chipped, cracked or otherwise defective products.
12. Ensure that all accessories are fitted in accordance with the manufacturers instructions.
13. Ensure that the abrasive accessory is correctly mounted and tightened before use. Run the tool with no-load for 30 seconds in a safe position and stop immediately if there is vibration or if other defects are detected. If this condition occurs, check the machine to determine the cause.
14. Check that the work piece is properly supported.
15. **DO NOT** use a cut-off wheel for side grinding.
16. Ensure that sparks resulting from use do not create a hazard or ignite flammable substances.
17. Ensure ventilation openings are kept clear when working in dusty conditions. If it should become necessary to clear dust, first disconnect the tool.
18. Personal protective equipment such as dust masks and gloves should be worn as appropriate.
19. Remember the wheel continues to briefly rotate after switching off.

ELECTRICAL CONNECTIONS



WARNING: READ THESE ELECTRICAL SAFETY INSTRUCTIONS THOROUGHLY BEFORE CONNECTING THE PRODUCT TO THE MAINS SUPPLY.

This product is provided with a standard BS 1363 plug, for connection to a standard, domestic electrical supply. Should the plug need changing at any time, ensure that a plug of identical specification is used.



**WARNING: THE WIRES IN THE POWER CABLE OF THIS PRODUCT ARE COLOURED IN ACCORDANCE WITH THE FOLLOWING CODE:
BLUE = NEUTRAL BROWN = LIVE**

If the colours of the wires in the power cable of this product do not correspond with the markings on the terminals of your plug, proceed as follows.

- The **Blue** wire must be connected to the terminal marked **N** or coloured **Black**.
- The **Brown** wire must be connected to the terminal marked **L** or coloured **Red**.

Plug must be BS1363/A approved.

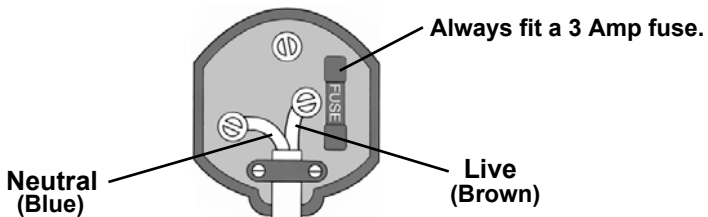

Ensure that the outer sheath of the cable is firmly held by the clamp

We strongly recommend that this machine is connected to the mains supply via a Residual Current Device (RCD)

If in any doubt, consult a qualified electrician. **DO NOT** attempt any repairs yourself.



This symbol indicates that this is a Class II product, and does not require an earth connection.

CARTON CONTENTS

The following items should be supplied. If any parts are missing or damaged, please contact the dealer where you purchased the rotary tool.

- Rotary tool
- Flexible drive
- Tool stand clamp
- Telescopic tool stand column
- Collection of miscellaneous accessories including chuck spanner
- Blow-moulded case

ASSEMBLING THE COMPONENTS

ERECTING THE STAND

Screw the telescopic tube into the bracket and tighten.

Clamp the bracket to a workbench or worktop with a maximum thickness of 65mm.

Slacken the top tube by turning the black knob anticlockwise. Draw the tube out to its maximum height and secure it by turning the knob clockwise.

Turn the middle tube anticlockwise and extend as required. Lock in position by turning the tube clockwise.

- The rotary tool can now be supported by the suspension bracket of the stand as shown. (the suspension bracket can be turned 360°).

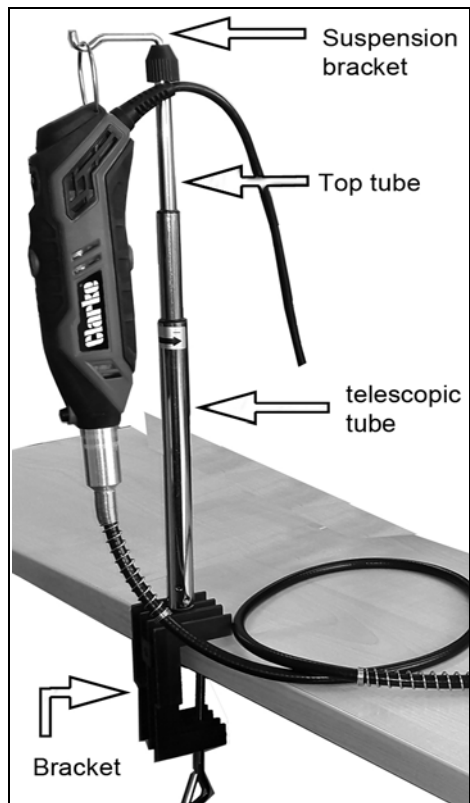

FITTING DISCS & GRINDING STONES TO THE MANDREL

1. Mount the selected disc on to the mandrel as shown, ensuring the two washers are in place.
- DO NOT overtighten the screw.

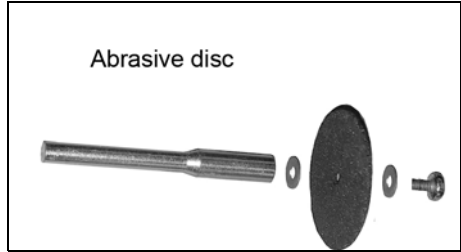

FITTING CLOTH POLISHING WHEELS

1. Screw the cloth wheel onto the mandrel firmly but do not overtighten.

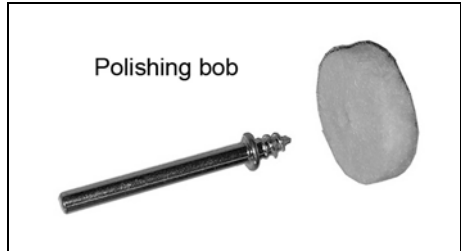

ASSEMBLING SANDING BANDS

1. Slacken the screw on the end of the mandrel and slide the appropriate abrasive band fully onto the rubber former.
2. Tighten the screw to secure the band to the former.

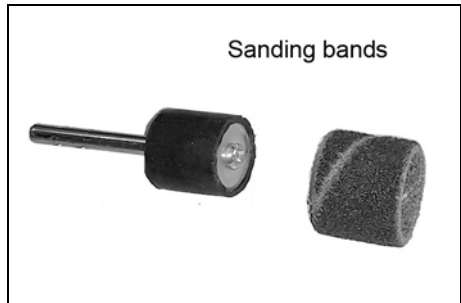

FITTING THE COLLET



WARNING: MAKE SURE THAT THE TOOL HAS BEEN DISCONNECTED FROM THE POWER SUPPLY BEFORE REMOVING OR FITTING A COLLET OR ACCESSORY

The rotary tool is supplied with 2 interchangeable collets; 2.3mm and 3.2mm (one supplied already fitted to the rotary tool).

Select the collet to be fitted according to the shaft size of the mandrel or other accessory to be used.

To fit a collet, proceed as follows.

1. Press and hold down the spindle lock.
 - It may be necessary to rotate the chuck to fully engage the spindle lock.

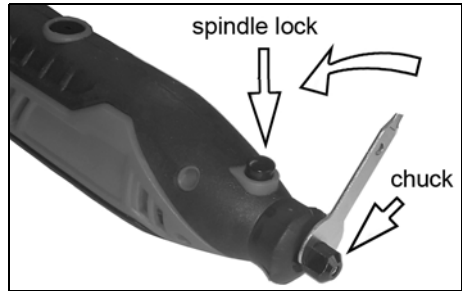

2. Remove the chuck by rotating the chuck sleeve in an anti-clockwise direction.

- A spanner is supplied for this purpose.

3. Pull the collet out of the spindle.
4. Insert the collet required, pushing it into the spindle as far as it will go.

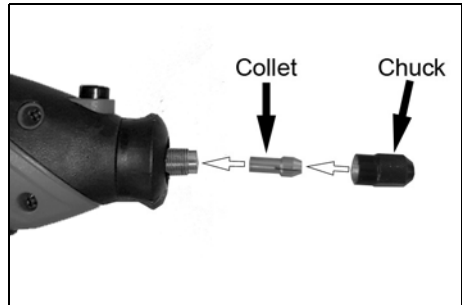

5. Refit the chuck, pressing the spindle lock to tighten it.

FITTING AN ACCESSORY TO THE TOOL

IMPORTANT: Ensure the tool is switched OFF

TO FIT AN ACCESSORY PROCEED AS FOLLOWS:

1. Make sure that the correct size collet has been fitted.
2. Press and hold down the spindle lock.
3. It may be necessary to rotate the chuck to engage the spindle lock.
4. Rotate the chuck sleeve in an anticlockwise direction until the collet jaws are open sufficiently to accept the accessory.

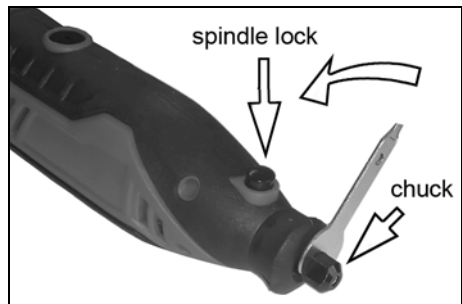

5. Insert the accessory into the collet as far as it will go.

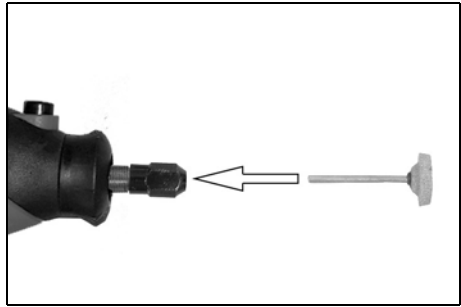

6. Press and hold down the spindle lock and tighten the chuck sleeve using the spanner supplied.

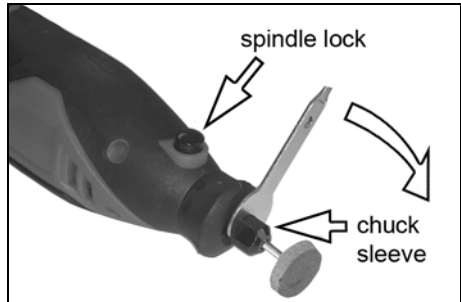

REMOVING THE ACCESSORY FROM THE COLLET

1. Press and hold down the spindle lock.
2. Using the spanner supplied, rotate the chuck sleeve in an anti-clockwise direction.
3. When the accessory is released, remove it.

ATTACHING THE FLEXIBLE DRIVE ASSEMBLY

1. Unscrew and remove the securing ring and store safely.
2. Slacken the chuck using the spanner provided while pressing and holding the locking button.
3. Slide the flexible drive through the chuck and fully into the collet.
4. Press and hold the locking button and screw the flexible drive assembly onto the end of the tool to secure it, taking GREAT CARE to not to cross-thread it.

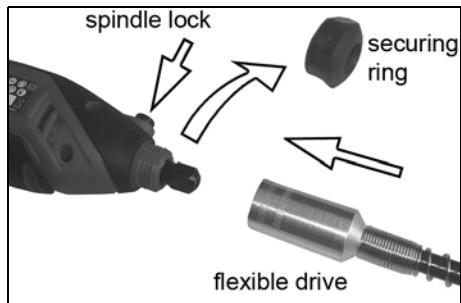

5. At the opposite end of the flexible drive rotate the drive until the hole in the flexible drive shaft lines up with the hole in the outer part so that the locking rod can be inserted.

- The spanner may now be used to tighten the collet and secure the mandrel.

6. Loosen the chuck and insert your chosen the mandrel before tightening.

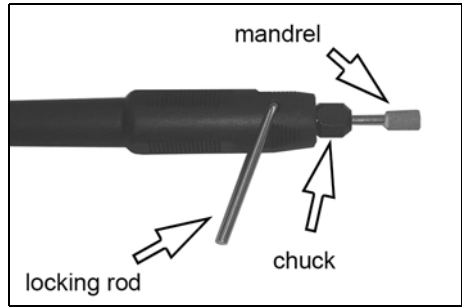

OPERATION



WARNING: BEFORE OPERATING THE ON/OFF SWITCH, MAKE SURE THAT THE COLLET AND ACCESSORIES HAVE BEEN CORRECTLY AND SECURELY FITTED.

1. To switch the rotary tool on, use the on/off switch.
 2. Select a suitable speed using the speed controller.
- The low speed settings (1-2) should be used for removing rust and polishing.
 - The medium speed settings (3-4) should be used for drilling, engraving, sharpening and removing paint.

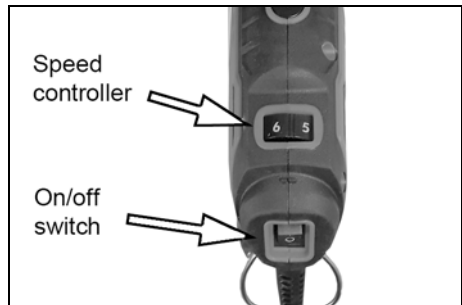

- The high speed settings (5-6) should be used for cutting metal and sanding wood.

3. Switch the rotary tool off, set the on/off switch to 0.



WARNING: NEVER PUT THE TOOL DOWN UNTIL IT HAS COMPLETELY STOPPED.

4. DO NOT use force when using this tool. A light pressure is all that is required.

TOOL ROTATIONAL SPEEDS

Speed indicator position	RPM
1	10,000
2	17,500
3	23,000
4	27,200
5	29,500
6	35,000

OPERATING SPEEDS

The following speeds are for guidance for working with different materials..

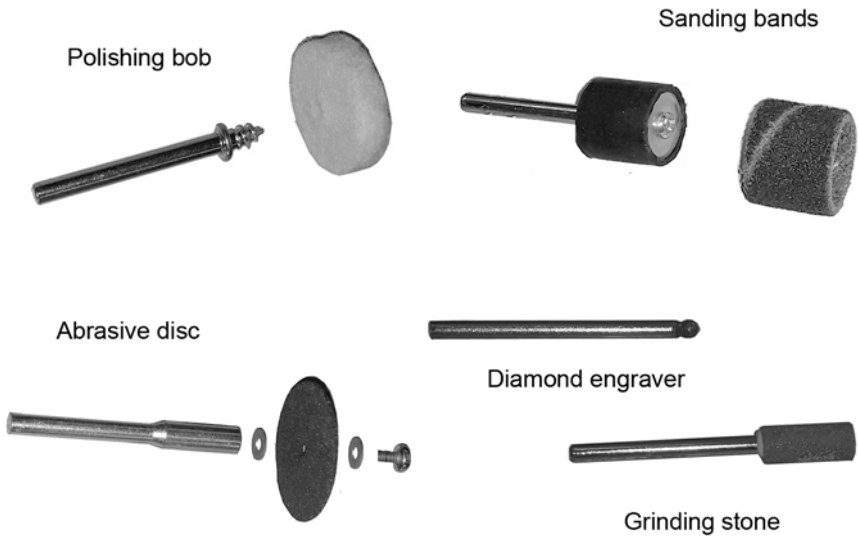

	Stone	Steel	Aluminium, brass	Polymer, plastic	Wood
Grinding stones	1	5	2	1	n/a
Abrasive disc	6	3	6	1	n/a
Sanding bands	n/a	1	3	1	6
Diamond engraver	6	3	6	1	n/a
Polishing bobs	n/a	5	3	5	n/a

CLEANING AND MAINTENANCE



WARNING: MAKE SURE THAT THE TOOL HAS BEEN DISCONNECTED FROM THE POWER SUPPLY BEFORE REMOVING OR FITTING A COLLET OR ACCESSORY

1. ALWAYS unplug the tool from the mains supply and ensure it is switched OFF when performing maintenance tasks.
2. The tool should be kept clean at all times. Ensure the ventilation ducts are clear and the power cable is in good condition. Get into the habit of cleaning thoroughly after each use and before storing.
3. After use, thoroughly clean all chippings and dust from the rotary tool, taking special care to clean the cooling vents.
4. Never clean with solvents. Use a moist cloth with soapy water if necessary.
5. Clean the spindle lock, the chuck and the spindle collar.
6. Keep all accessories sharp and clean.

The tool incorporates sealed for life bearings and does not require lubrication.

There are no user serviceable parts inside this tool.

Worn or damaged parts should be replaced by qualified personnel.

Refer to qualified service personnel if internal maintenance is required.

ACCESSORIES

Accessory Kits are available from your dealer. Please quote part number 6468025 (CRT100A - 100 piece).

ENVIRONMENTAL RECYCLING POLICY



By purchasing this product, the customer is taking on the obligation to deal with its safe disposal in accordance with the Waste Electrical and Electronic Equipment (WEEE).

This product must not be disposed of with general household waste but be disposed of according to the laws governing Waste Electrical and Electronic Equipment (WEEE) at a recognised disposal facility.

This product contains valuable raw materials. Metal products should be taken to your local civic amenity site for recycling.

COMPONENT PARTS

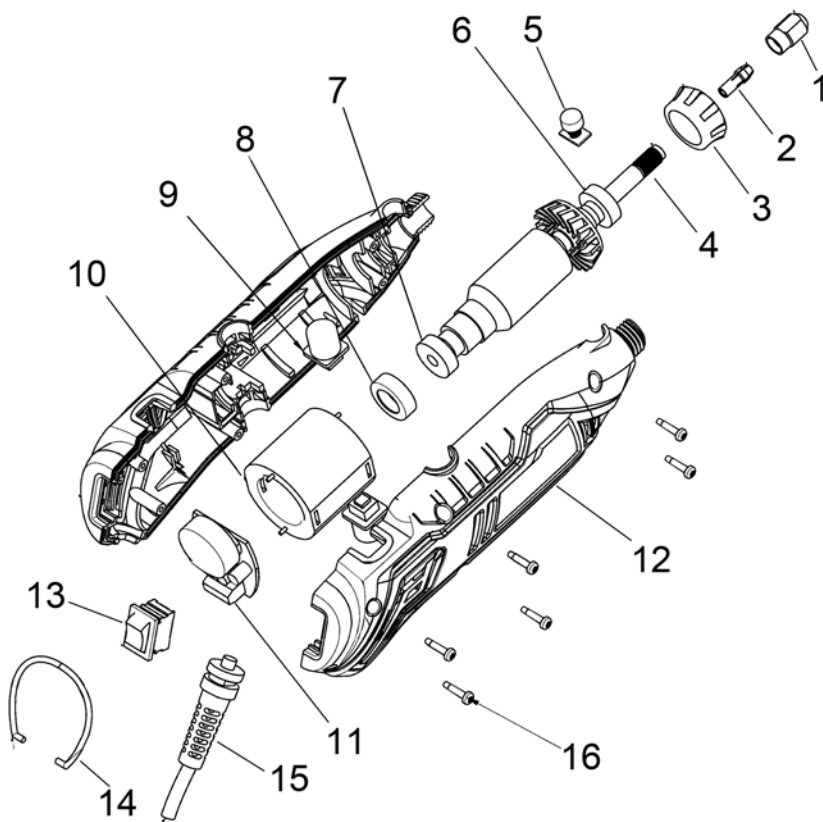

No	Description
1	Chuck sleeve
2	Collet
3	Cap body
4	Rotor
5	Spindle lock button
6	Bearing 968z
7	Bearing 626z
8	Bearing sleeve

No	Description
9	Carbon brush
10	Stator
11	Circuit board
12	Housing
13	Switch
14	Hanger
15	Cable & plug
16	Screw

DECLARATIONS OF CONFORMITY



Fitwillom Hall, Fitzwilliam Place, Dublin 2

DECLARATION OF CONFORMITY

This is an important document and should be retained.

We hereby declare that this product(s) complies with the following legislation:

- 2014/30/EU Electromagnetic Compatibility Directive
- 2006/42/EC Machinery Directive
- 2011/65/EU Restriction of Hazardous Substances (RoHS) Directive

The following standards have been applied to the product(s):

- EN IEC 61000-3-2:2019+A1:2021, EN 61000-3-3:2013+A1:2019, EN 60745-1:2009+A11:2010, EN IEC 58014-1:2021, EN IEC 58014-2:2021, IEC 62321-7-1:2015, IEC 62321-7-2:2017, IEC 62321-3-1:2013, EN 60745-2:23:2013, IEC 62321-4:2017, IEC 62321-5:2013, IEC 62321-6:2015, IEC 62321-8:2017

The technical documentation required to demonstrate that the product(s) meet(s) the requirement(s) of the aforementioned legislation has been compiled and is available for inspection by the relevant enforcement authorities.

The CE mark was first applied in: 2020

Product Description:	Rotary Tool
Model Number(s):	CRT130
Serial/Batch Number:	Refer to product/packaging label
Date of Issue:	26/10/2023

J.A. Clarke
Director



Hemnal Street, Epping, Essex, CM16 4LG

DECLARATION OF CONFORMITY

This is an important document and should be retained.

We hereby declare that this product(s) complies with the following legislation:

- The Electromagnetic Compatibility Regulations 2016
- The Supply of Machinery (Safety) Regulations 2008
- The Restriction of the Use of Certain Hazardous Substances in Electrical and Electronic Equipment Regulations 2012

The following standards have been applied to the product(s):

- EN IEC 61000-3-2:2019+A1:2021, EN 61000-3-3:2013+A1:2019, EN 60745-1:2009+A11:2010, EN IEC 58014-1:2021, EN IEC 58014-2:2021, IEC 62321-7-1:2015, IEC 62321-7-2:2017, IEC 62321-3-1:2013, EN 60745-2:23:2013, IEC 62321-4:2017, IEC 62321-5:2013, IEC 62321-6:2015, IEC 62321-8:2017

The technical documentation required to demonstrate that the product(s) meet(s) the requirement(s) of the aforementioned legislation has been compiled and is available for inspection by the relevant enforcement authorities.

The UKCA mark was first applied in: 2021

Product Description:	Rotary Tool
Model Number(s):	CRT130
Serial/Batch Number:	Refer to product/packaging label
Date of Issue:	26/10/2023

J.A. Clarke
Director

A SELECTION FROM THE VAST RANGE OF

Clarke®

QUALITY PRODUCTS



AIR COMPRESSORS
From DIY to industrial, Plus air tools,
spray guns and accessories.

GENERATORS
Prime duty or emergency standby
for business, home and leisure.

POWER WASHERS
Hot and cold, electric and engine
driven - we have what you need

WELDERS
Mig, Arc, Tig and Spot.
From DIY to auto/industrial.

METALWORKING
Drills, grinders and saws for DIY
and professional use.

WOODWORKING
Saws, sanders, lathes, mortisers
and dust extraction.

HYDRAULICS
Cranes, body repair kits,
transmission jacks for all types of
workshop use.

WATER PUMPS
Submersible, electric and engine driven
for DIY, agriculture and industry.

POWERTOOLS
Angle grinders, cordless drill sets,
saws and sanders.

STARTERS/CHARGERS
All sizes for car and commercial use.



PARTS & SERVICE:
0208 988 7400

Parts Enquiries
Parts@clarkeinternational.com

Servicing & Technical Enquiries
Service@clarkeinternational.com

SALES: UK 01992 565333 or Export 00 44 (0)1992 565335

Clarke INTERNATIONAL Hemnall Street, Epping, Essex CM16 4LG
www.clarkeinternational.com